

Performance

Bucket capacity	0.8 m ³
Bucket range	0.6 - 1.5 m ³
Tipping load bucket, straight (ISO 14397-1)	3964 kg
Tipping load bucket, articulated at 40° (ISO 14397-1)	3339 kg
Tipping load forks, straight (ISO 14397-1)	3011 kg
Tipping load forks, articulated at 40° (ISO 14397-1)	2619 kg
Lift breakout force (ISO 14397-2)	4978 kg
Lift capacity (ISO 14397-2)	2312 kg
Maximum travel speed — Range I	25.0 km/h
Maximum travel speed — Range II	40.0 km/h

Engine

Model	2.4L V2 BOBCAT ENGINE
Compliancy	STAGE V
Cooling	Liquid
Fuel	Diesel
Fuel Tank	78.80 L
Power at 2600 RPM (ISO 14396):	55.2 kW

Weights

Operating weight, standard (ISO 6016)	5376 kg
Shipping weight, standard (ISO 6016)	4896 kg
Max. static axle load	6000 kg
Max. dynamic axle load	6000 kg

Hydraulic System

Control valve	3 spool (optionally 4) - parallel series type - open center
System Relief @ Quick Couplers - High Flow (Option)	22.5 MPa
System Relief @ Quick Couplers	20.5 MPa
Hydraulic Tank	27.20 L
Auxiliary Std Flow	75.40 L/min
Auxiliary High Flow	103.50 L/min

Drive System

Main Drive	Proportionally regulated hydrostatic motor
Transmission	Hydrostatic with electronic regulation

Controls

Vehicle steering	Machine articulation via hydraulic steering with steering wheel
Travel Direction	Travel direction switch (F-N-R) on joysticks. Drive pedal in work and travel mode.
Machine hydraulics	Dual axis joystick for lift, tilt and auxiliary
Vehicle braking	Combination of integrated 6 wet brake disk in rear axle with hydrostatic braking effect provision

Environmental

Noise level LpA(EU Directive 2000/14/EC)	100 dB(A)
Noise level LWA(at operator's ear)	77 dB(A)
Whole body vibration below	0.63 ms ⁻²
Hand-arm vibration below	1.31 ms ⁻²

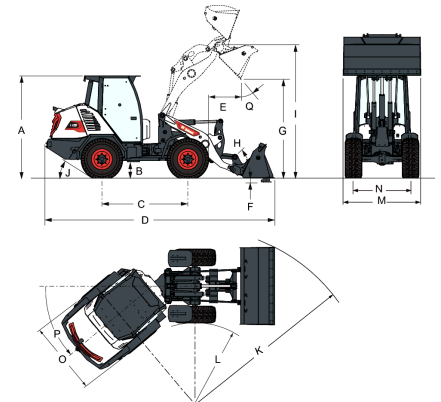
Dimensions

(A)	2522.7 mm	(J)	33.3°
(B)	452.0 mm	(K)	4280.4 mm
(C)	2100.0 mm	(L)	1985.6 mm
(D)	5433.6 mm	(M)	1900.0 mm
(E)	660.5 mm	(N)	1393.0 mm
(F)	75.0 mm	(O)	1800.0 mm
(G)	2532.5 mm	(P)	40.0°
(I)	3275.0 mm	(Q)	45.0°

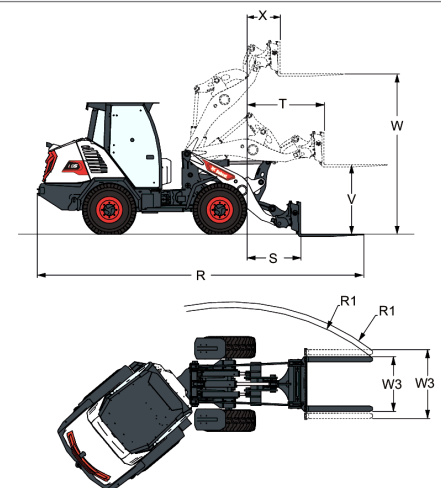
Dimensions - Pallet fork

(R)	5959.1 mm	(V)	1399.0 mm
(R1)	4262 - 4472.6 mm	(W)	416.4 mm
(S)	750.1 mm	(W3)	773.6 - 1313.6 mm
(T)	1252.2 mm	(X)	416.4 mm